

Products: R&S®SMJ100A, R&S®SMU200A, R&S®AMU200A, R&S®AFQ100A, R&S®FSL, R&S®FSP,
 R&S®FSU, R&S®FSQ, R&S®ZVL

Measurements on RFID Components According to ISO/IEC 14443 Standard

Application Note

This Application Note describes measurements on RFID readers and chipcards according to ISO/IEC 14443 and similar standards, using a signal generator and a spectrum analyzer. Using a modern spectrum analyzer like the R&S®FSL not only increases accuracy and measurement speed, but also simplifies operation. Interoperability tests, in particular, are simplified by generating reader test signals with a signal generator. With software option R&S®SMx/AMU/AFQ-K6 chipcards can be tested without a reader.



Contents

1	Abstract	3
2	Overview of ISO/IEC 14443 RFID Standard	4
	Carrier Frequency	4
	Magnetic Field	4
	Bit Rate	5
	Modulation	5
	Coding	7
3	Test Setup	7
	With RFID Reader	7
	Simulating a Reader with a Signal Generator	9
	Advantages of Spectrum Analysis in Measurements on ISO/IEC 14443 Signals	10
	Matching the PCD Antenna Using the Network Analyzer	11
	Determining the Transducer Coefficient	12
	Example: Procedure for Determining the Transducer Coefficient Using an Active Probe on an R&S®FSL with the Tracking Generator Option	12
4	Signal Generation	14
	RFID Reader Signal Generated by R&S xxx-K6 Pulse Sequencer Application Software and Signal Generator	14
5	Signal Analysis on Reader Signals (PCDs)	18
	Reader Field Strength	18
	Reader Modulation Waveform	20
6	Signal Analysis on Chipcards (PICCs)	23
	Frame Delay Time	23
	Load Modulation	26
	Time Domain Power Measurement	28
	Electromagnetic Disturbance	32
7	Abbreviations	34
8	References	36
9	Additional Information	36
10	Appendix	37
	Generating ISO/IEC 14443 Type A Signals	37
	Generating ISO/IEC 14443 Type B Signals	44
11	Ordering Information	53

1 Abstract

This Application Note (AN) describes the measurements defined in ISO/IEC 10373-6 for RFID readers and chipcards in line with ISO/IEC 14443. Measurements are carried out using signal generators and spectrum analyzers from Rohde & Schwarz. Using a modern spectrum analyzer such as the R&S®FSL for signal analysis not only increases accuracy and measurement speed, but also simplifies operation. Interoperability tests, in particular, are simplified by the generating reader signals using a signal generator from Rohde & Schwarz. The R&S®SMx-K6 option provides functions for testing on chipcards without reader. Basic example files (REQA-, WUPA- signals) are delivered with this application note.

Many newer RFID standards are based on the ISO/IEC 14443 standard: This application note also includes test notes for other standards, including NFC and ISO/IEC 18000.

The following abbreviations are used in this Application Note for Rohde & Schwarz test equipment:

- The Vector Signal Generator R&S®SMJ100A is referred to as the SMJ.
- The Vector Signal Generator R&S®SMU200A is referred to as the SMU.
- The I/Q Modulation Generator R&S®AMU200A is referred to as the AMU.
- The I/Q Modulation Generator R&S®AFQ100A is referred to as the AFQ.
- The Spectrum Analyzer R&S®FSL is referred to as the FSL.
- The Spectrum Analyzer R&S®FSP is referred to as the FSP
- The Spectrum Analyzer R&S®FSU is referred to as the FSU
- The Signal Analyzer R&S®FSQ is referred to as the FSQ
- The Vector Network Analyzer R&S®ZVL is referred to as the ZVL

The R&S logo, Rohde & Schwarz, and R&S are registered trademarks of Rohde & Schwarz GmbH & Co. KG and its subsidiaries.

2 Overview of ISO/IEC 14443 RFID Standard

The "Identification Cards – Contactless integrated circuit(s) cards – Proximity cards" ISO/IEC 14443 standard describes the structure, function, and operation of proximity coupling cards; for example, when used as SMART cards. The standard refers to the reader as a proximity coupling device (PCD) and to the card as a proximity integrated coupling circuit (PICC). Tables and illustrations are taken from the ISO/IEC 14443 and 10373-6 standards. Detailed information is available from the corresponding ISO/IEC standards.

Parameters	Type A	Type B
Power supply	13.56 MHz inductive coupling	
Field strength	1.5 A/m to 7.5 A/m	
PCD-to-PICC communication	ASK 100 %, modified Miller coding	ASK 10 %, NRZ coding
PICC-to-PCD communication	load modulation with 847.5 kHz sidebands	
	106 kbit/s: OOK-modulated, Manchester 212 kbit/s to 848 kbit/s: BPSK, NRZ-L coding	106 kbit/s to 848 kbit/s: BPSK, NRZ-L coding
Anticollision	binary search tree	slotted ALOHA

Table 1 Basic characteristics of ISO/IEC 14443 Type A and Type B

Carrier Frequency

The carrier frequency (f_c) of an RFID system as defined by ISO/IEC 14443 is 13.56 MHz \pm 7 kHz. The carrier is used to supply power to the PICC via a transformer coupling and the resulting induced voltage. The modulation of the carrier signal allows the PCD to transmit information to the PICC.

Magnetic Field

The PCD generates a magnetic field with a minimum field strength of H_{min} 1.5 A/m and a maximum field strength of H_{max} 7.5 A/m. These values are measured while the PCD carrier is in an unmodulated state by using a high-

impedance voltage measurement on the calibration coil (refer to Chapter 5, Reader Field Strength).

Bit Rate

The bit rate when communication is being initialized is 106 kbit/s, which corresponds to the quotient $f_c/128$. After initialization, the following bit rates are available depending on the PICC function:

- $f_c/128 = 105,9375$ kbit/s (~106 kbit/s)
- $f_c/64 = 211,875$ kbit/s (~212 kbit/s)
- $f_c/32 = 423,75$ kbit/s (~424 kbit/s)
- $f_c/16 = 847,5$ kbit/s (~848 kbit/s)

Modulation

The PCD uses an amplitude modulation of the carrier frequency to transmit information. The modulation used is either Type A or Type B. During communication from PCD to PICC, Type A is used, providing 100 % amplitude modulation, or on-off keying (OOK). Type B involves 10 % amplitude shift keying (ASK).

In the communication from PICC to PCD, a distinction must be made between the individual bit rates. Different modulation types are used depending on the bit rate.

To detect whether a Type A or Type B PICC is present in the PCD operating field, the PCD alternates the modulation. It then selects the modulation matching the PICC type in order to initialize communication.

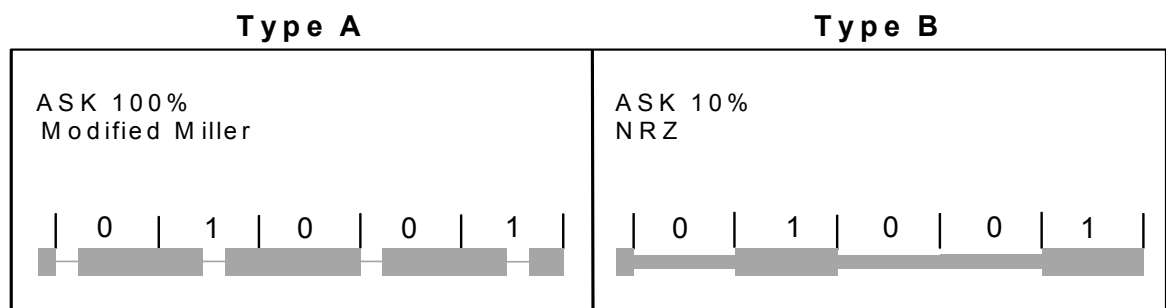

Fig. 1 PCD-to-PICC communication

Measurements on RFID Components according to 14443

During type A transmissions from PICC to PCD, the sidebands are modulated at a bit rate of $f_c/128$ using on-off keying (OOK). At higher bit rates ($f_c/64$, $f_c/32$, $f_c/16$), binary phase shift keying (BPSK) is used. Type B uses the BPSK modulation mode for all bit rates ($f_c/128$, $f_c/64$, $f_c/32$, $f_c/16$).

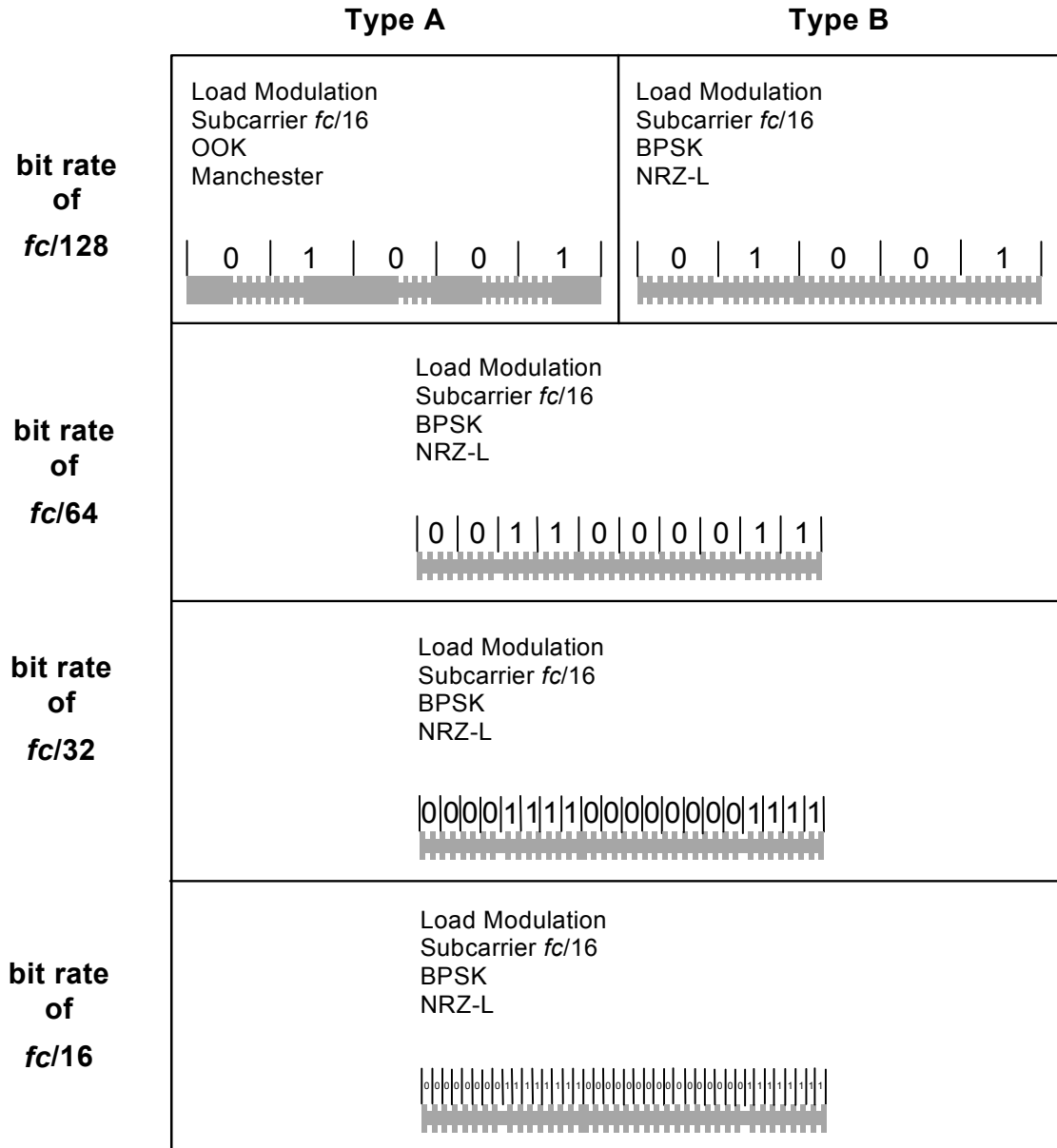

Fig. 2 PICC-to-PCD communication

Coding

Different codings are used depending on whether the chipcard is of Type A or Type B and depending on the bit rate:

Data transmission from PCD to PICC:

Type A: Modified Miller coding for Type A

Type B: Non-return to zero level coding (NRZ-L)

Data transmission from PICC to PCD:

Type A with bit rate of $f_c/128$: Manchester coding

Type A with bit rate greater than $f_c/128$ and Type B: NRZ-L coding

3 Test Setup

With RFID Reader

Proximity coupling cards in line with ISO/IEC 14443 Type A and Type B are tested using the test assembly described in ISO/IEC 10373-6 (*"Identification Cards - Test Methods – Part 6: Proximity Cards"*). The main task of the test assembly is to suppress the 13.56 MHz PCD carrier. This simplifies the measurement of the load modulation sidebands, where the level is about 60 dB lower than with the carrier signal. The carrier signal is suppressed by means of a symmetrical setup of the bridge. A voltage is induced into each of the two sense coils, and these two voltages negate one another when an optimal setup of the bridge is achieved. To this end, any asymmetrical setup can be compensated by means of a potentiometer on the bridge. This reduces the influence of the PCD antenna to a minimum. Fig. 3 shows the test assembly with the connected probe. When performing high-impedance measurements with a spectrum analyzer, it is best to use an active probe, such as the HAMEG HZ 109. This will ensure matching with the analyzer's 50 Ω RF input.

Measurements on RFID Components according to 14443

The PCD antenna, which is connected to an RFID reader or signal generator, is equipped with an impedance matching network. This ensures that the PCD antenna is matched to the input impedance of the reader or signal generator (50Ω). To achieve a lower quality factor, and thus a higher bandwidth of the PCD antenna, a modified version of the impedance matching network must be used for bit rates greater than $f_c/128$.

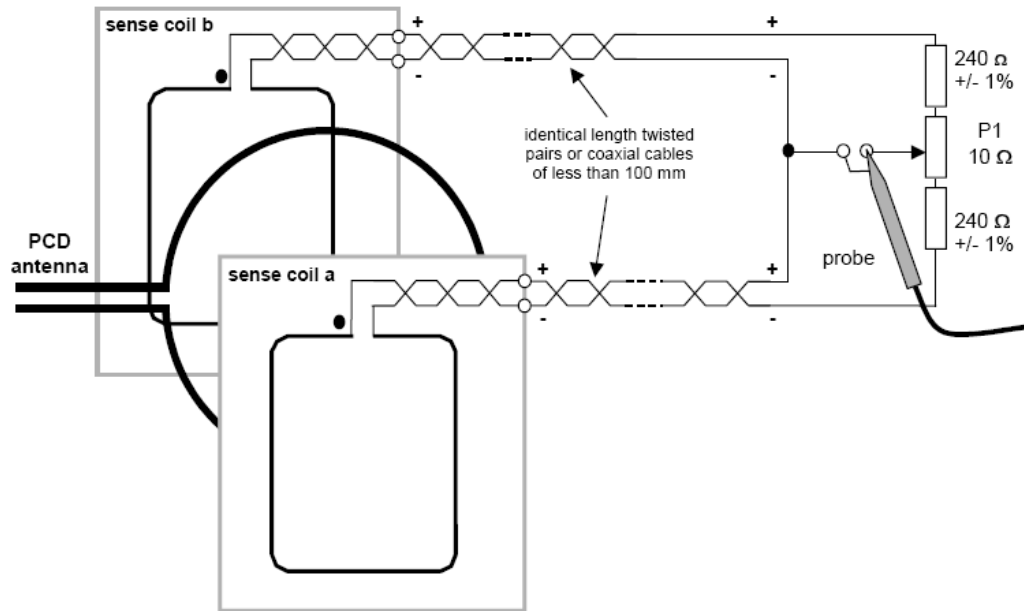

Fig. 3 Schematic of the ISO/IEC test assembly

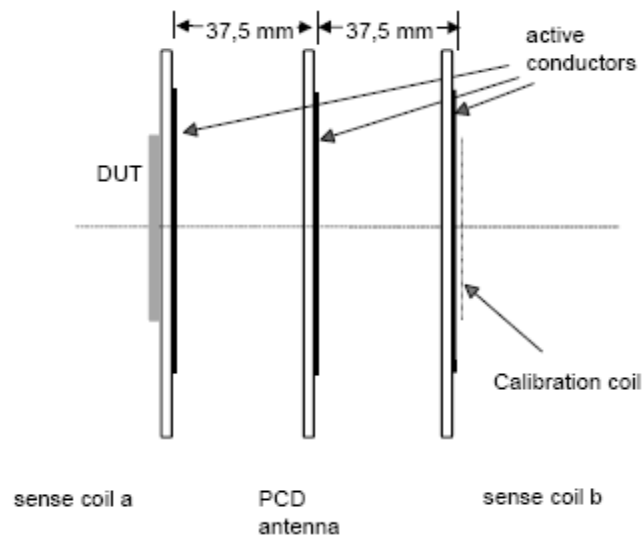

Fig. 4 Structure of the ISO/IEC test assembly

Simulating a Reader with a Signal Generator

The test setup in accordance with ISO/IEC 14443 using a signal generator is also based on the specifications provided in ISO/IEC 10373-6. The PCD antenna of the test assembly is connected to the RF output of the signal generator via an amplifier. The amplifier ensures the proper field strength for the PCD antenna. The voltage change on the bridge is obtained as described above with an active probe and routed to a spectrum analyzer. The spectrum analyzer is supplied by an external trigger signal (ext trigger input) generated by the signal generator (marker 1 output). The following illustration shows the described setup.

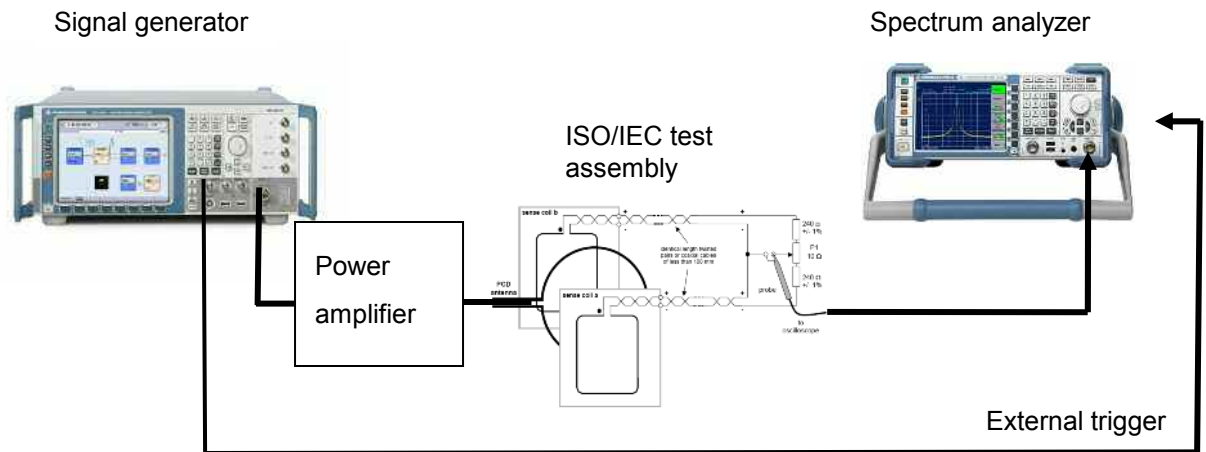

Fig. 5 Test setup

Advantages of Spectrum Analysis in Measurements on ISO/IEC 14443 Signals

A modern spectrum analyzer, such as the R&S®FSL, offers distinct advantages over the commonly used digital scope. The higher resolution of its A/D converter (14 bits as compared to 8 bits) allows a significant greater dynamic range.

The precise envelope representation of a spectrum analyzer considerably eases the measurement of modulation parameters. Compared to an oscilloscope, it is not necessary to interpolate between the peaks of the RF curve. Due to the logarithmic display, small amplitude values are represented more clearly.

With time measurements, such as frame delay time, the corresponding number of sweep points can be selected (maximum 32001 for the R&S®FSL) to achieve maximum time resolution (e.g. 3 ns at 100 µs sweep time).

Load modulation amplitude is measured selectively and almost in realtime over the complete response duration. This means that with a spectrum analyzer the load modulation amplitude can be observed as the PCD field strength changes over time, for example. On the other hand with a digital scope, the results of the load modulation must be laboriously calculated using an FFT of a suitable time segment.

The steep slope of the 1 MHz channel filter on R&S analyzers completely suppresses the PCD carrier. The flat level response in a wide passband ensures accurate recording of the load modulation spectrum, even at high bit rates. A low measurement uncertainty over the wide dynamic range guarantees precise and accurate measurements with analyzers by Rohde & Schwarz.

Matching the PCD Antenna Using the Network Analyzer

A simple and precise impedance matching can be carried out using a network analyzer (e.g. the R&S@ZVL). To do this, the network analyzer is calibrated and then connected to the PCD antenna via an RF cable, after which an s_{11} reflection coefficient measurement is carried out. The S-parameter as well as the magnitude and phase of the PCD's complex impedance can then be displayed in a Cartesian diagram or a Smith chart. By modifying the adjustable capacity of the impedance matching network, the PCD antenna can be optimally tuned. The following measurements were carried out using an R&S@ZVL, which, when equipped with the R&S@ZVL-K1 option, provides the full functionality of an R&S@FSL spectrum analyzer. This means that in addition to the measurements on the PCD for impedance matching and resonance frequency, this device can also be used for all other measurements required by the ISO/IEC standard as described in this Application Note.

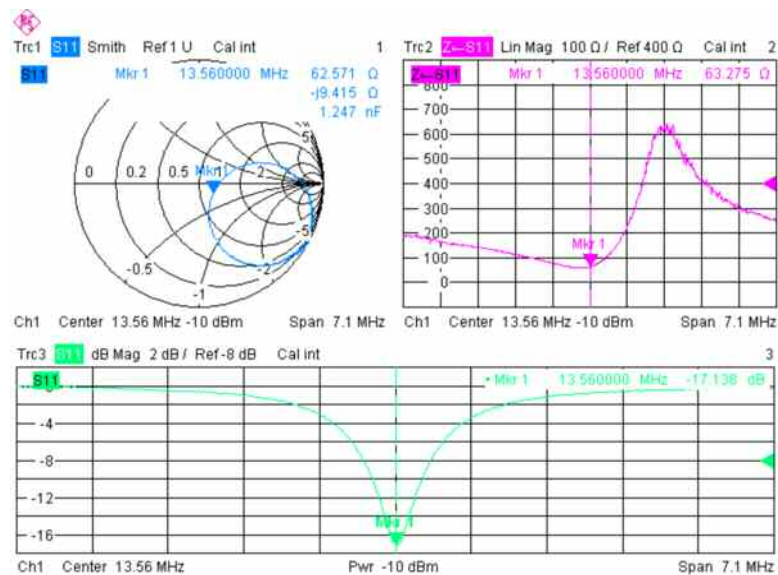

Fig. 6 s_{11} measurement of the PCD using an R&S@ZVL

Determining the Transducer Coefficient

The transducer coefficient can be used to correct signal attenuation, gain, and frequency dependency of the probe being used. Determining the individual coefficient makes it possible to analyze the results so that an exact measurement is possible over the frequency range. To determine the transducer coefficient, the probe is used to measure a known signal, for example of an RF signal generator, or even directly on the tracking generator of the spectrum analyzer used.

Example: Procedure for Determining the Transducer Coefficient Using an Active Probe on an R&S®FSL with the Tracking Generator Option

Use the probe for measurements on the spectrum analyzer's generator output connector.

PRESET

MENU: *TrackingGenerator:Source on*

MENU: *TrackingGenerator:SourcePower:6 dB*

NOTE: The levels of the tracking generator (actually of every RF signal generator) are referenced to a connection with an impedance of 50 Ω . Without this connection – that is, measured with a high-impedance probe – the level at the output connector is 6 dB higher, i.e. in this case 0 dB.

SPAN: *Start:5 MHz*

SPAN: *Stop:20 MHz*

AMPT: *Ref Level:-6 dBm*

SWEEP: *Man Sweeptime:500 ms*

TRACE: *DetectorManualSelect:RMS*

MKR:Marker1: 5 MHz/10 MHz/13,56 MHz/15 MHz/ 20 MHz

Note the dB value of marker 1.

Select additional measurement points, such as 10 MHz, 13.56 MHz, 15 MHz, and 20 MHz, and note their results.

SETUP:Transducer:New:[Probe1]

Measurements on RFID Components according to 14443

Now enter the determined dB values (e.g. for 5/10/13.56/15/20 MHz) with an **inverted** sign.

- After all values are entered, save the transducer coefficient by clicking **Save**.

SETUP:Transducer:Save

- Select the new transducer coefficient from the Transducer menu and activate it by clicking **Active on**.

1. Check the transducer coefficient.

- The trace should now be at exactly 0 dBm ± 0.1 dB . This should be checked against MARKER 1, in particular for the calibration frequencies 5/10/13.56/15/20 MHz.
- The analyzer is now calibrated to the probe in the frequency range of 5 MHz to 20 MHz.

4 Signal Generation

RFID Reader Signal Generated by R&S xxx-K6 Pulse Sequencer Application Software and Signal Generator

The R&S@xxx-K6 pulse sequencer software is ideally suited for generating simple reader frames, e.g. "Request Command Type A" (REQA) or "Request Command Type B" (REQB). This software can be used to generate complex pulses and pulse sequences. A wide variety of modulation modes and codings are available, and these can be expanded as needed by using external plugins. The pulse files generated in this manner can then be transferred and output to one of the R&S@SMU200A, R&S@SMJ200A, R&S@SMATE200A, R&S@AMU200A, or R&S@AFQ100A signal generators. To do this, the signal generator requires the R&S@xxx-K6 pulse sequencer option.

Various files are supplied with this Application Note. These include the corresponding project files (*.PRJ) and modulation plugins (*.DLL) for the R&S@xxx-K6 pulse sequencer software, which are used to generate several RFID frames as described in the appendix. The files also include the waveform files (*.WV) generated using these project files. The project files can be modified as needed using the pulse sequencer software. The waveform files can be transferred directly to the generator, for example, using a USB stick.

The following project files (*.PRJ) are available:

For RF generators (SMU and SMJ):

- 14443TypeA.prj ISO/IEC 14443 Type A frames
- 14443TypeB.prj ISO/IEC 14443 Type B frames

For baseband generators (AMU200A and AFQ):

- 14443TypeA_ZF.prj ISO/IEC 14443 Type A frames
- 14443TypeB_ZF.prj ISO/IEC 14443 Type B frames

The *.PRJ files are loaded into the pulse sequencer software using the File/Load Project menu and then modified as needed. The appendix to this

Measurements on RFID Components according to 14443

Application Note describes the generation of ISO/IEC 14443 signals using R&S@xxx-K6.

The following modulation plugins are available:

ISO-IEC14443-2-TypeA.dll Type A Modulation Plugin

ISO-IEC14443-2-TypeB.dll Type B Modulation Plugin

The plugin files have to be copied to the R&S@xxx-K6 pulse sequencer plugin directory.

The following waveform (*.WV) files are available and can be loaded directly to a Rohde & Schwarz signal generator with an R&S@xxx-K6 option, e.g. using a USB stick:

For RF generators (SMU and SMJ):

- REQA.wv ISO/IEC 14443 Type A request frame
- WUPA.wv ISO/IEC 14443 Type A wake up frame
- REQB.wv ISO/IEC 14443 Type B request frame
- WUPB.wv ISO/IEC 14443 Type B wake up frame

For baseband generators (AMU and AFQ):

- REQA_ZF.wv ISO/IEC 14443 Type A request frame
- WUPA_ZF.wv ISO/IEC 14443 Type A wake up frame
- REQB_ZF.wv ISO/IEC 14443 Type B request frame
- WUPB_ZF.wv ISO/IEC 14443 Type B wake up frame

A frame is activated under the ARB Arbitrary Waveform Generator menu item of the signal generator used.

Measurements on RFID Components according to 14443

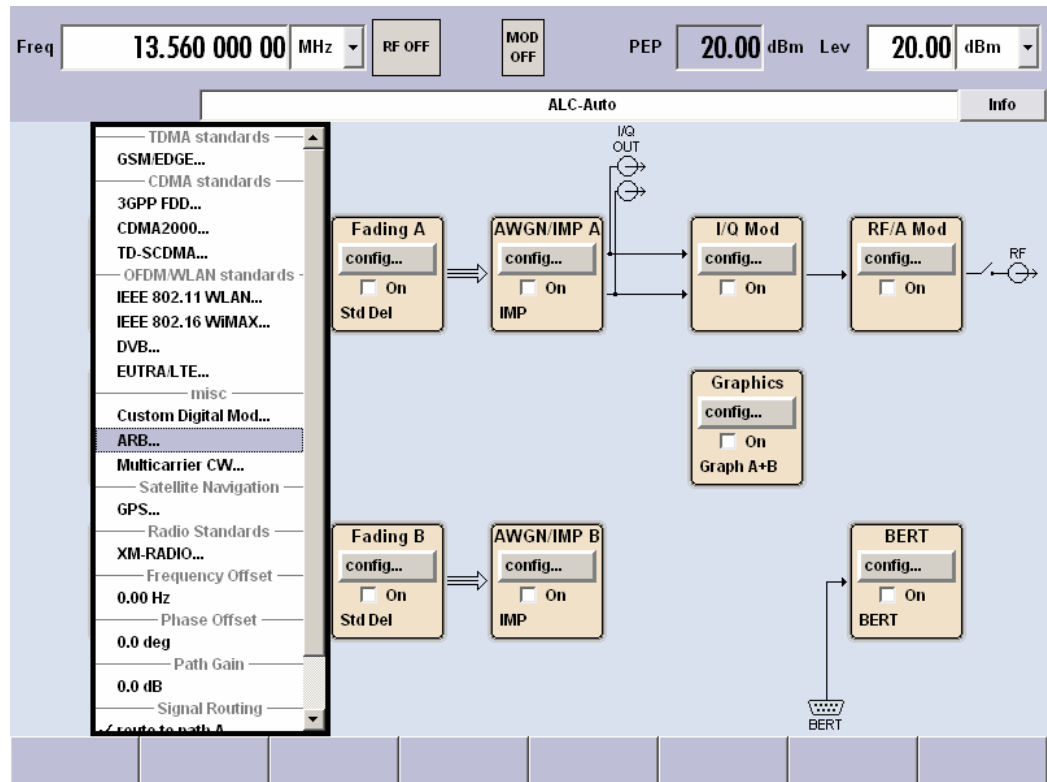

A trigger signal for the spectrum analyzer is available under the Trigger/Marker menu.

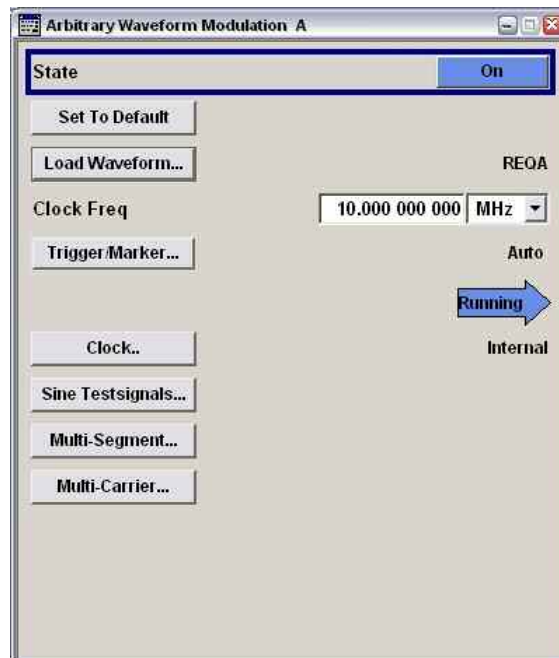

Measurements on RFID Components according to 14443

This is done with the Marker 1 – Restart option. The trigger pulse is then present at marker 1 connector 1 at the front of the signal generator.

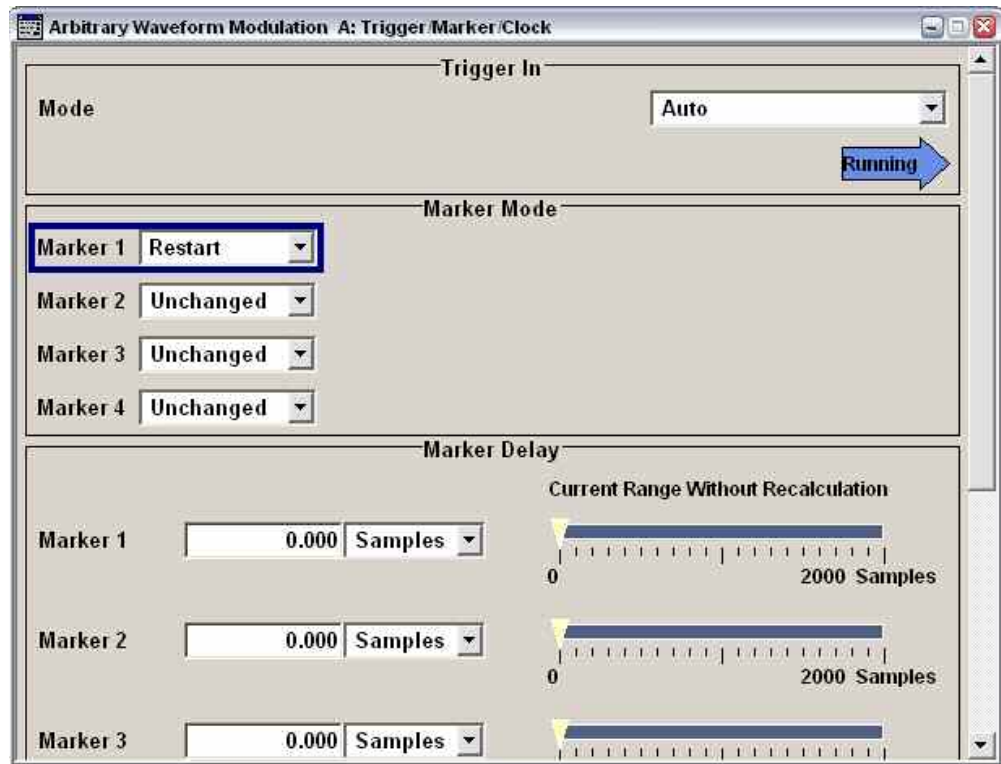

After the baseband block as well as the I/Q Mod and RF Mod blocks are activated, the RFID signal can be obtained at the RF output of the signal generator. The signal frequency (in the case of ISO/IEC 14443 this is 13.56 MHz) and level are displayed in the upper section of the diagram and can be set using the **FREQ** and **LEVEL** keys. If the RFID signal is generated in the IF (e.g. on an R&S®AMU baseband generator), this is obtained directly at the I output of the generator.

5 Signal Analysis on Reader Signals (PCDs)

Reader Field Strength

The PCD field strength can be determined by a high-impedance voltage measurement using the spectrum analyzer at the calibration coil of the ISO/IEC test assembly. Every 0.32 Volt RMS of measured voltage corresponds to a field strength of 1 A/m (refer to ISO/IEC 10373-6, section 6.1.3).

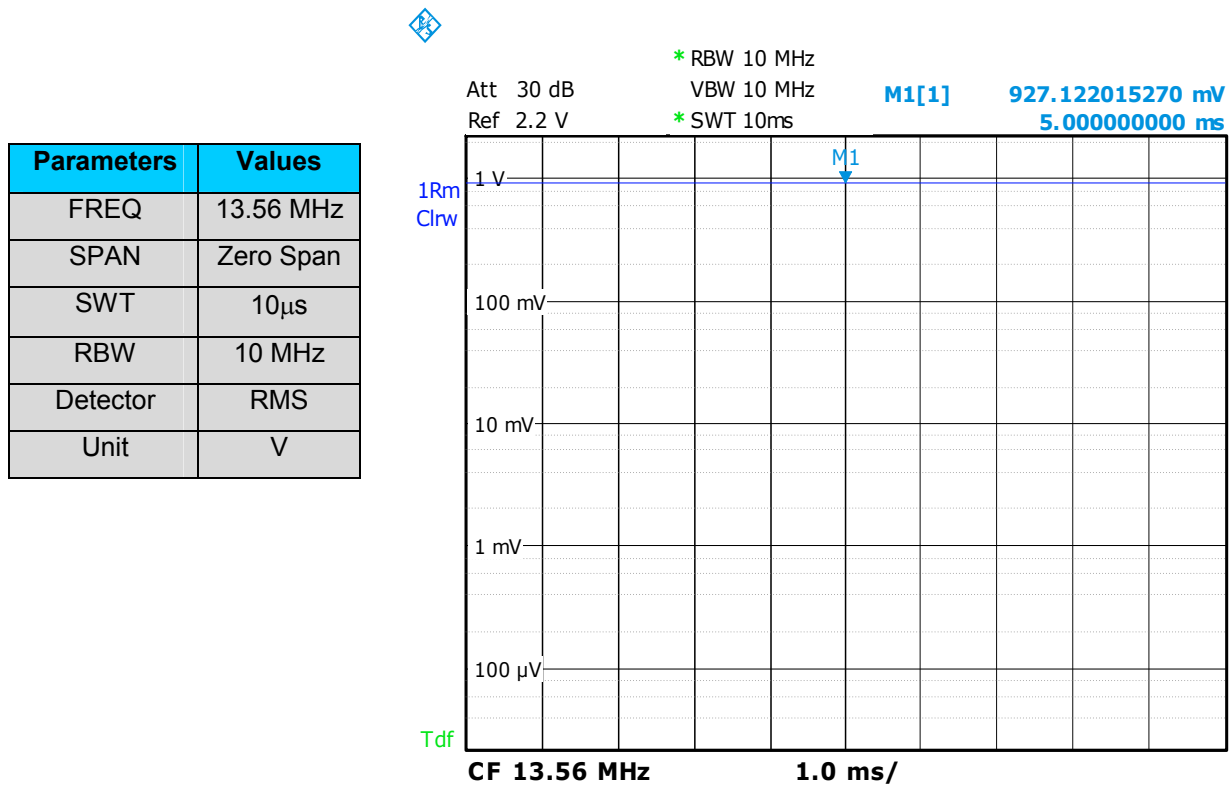

Fig. 7 Voltage measurement at the calibration coil

The following settings must be made on the spectrum analyzer (e.g. the R&S®FSL) in order to measure the PCD field strength.

PRESET

FREQ:13,56 MHz

SPAN:ZeroSpan

BW:10 MHz

Measurements on RFID Components according to 14443

SETUP: *Transducer:Active ON*

AMPT: *Unit:V*

TRACE: *Detector Manual Select:RMS*

MKR: *MARKER1*

The RMS voltage value can now be read at marker M1.

The field strength of the PCD is calculated as follows:

$$FieldStrength_{PCD} = \frac{Voltage_{CalibrationCoil}}{0.32V}$$

Reader Modulation Waveform

This measurement determines the time parameters for the modulation envelope described in section 8.1.2.1 of ISO/IEC 14443-2. In contrast to the displays described in the ISO/IEC 14443 standard and the measurement on an oscilloscope, the measurements carried out on the spectrum analyzer are displayed logarithmically and not linearly. This results in a difference in how the envelope shape of the PCD modulation is displayed. Normally, the various measurement points of the falling and rising edges of the PCD modulation envelope are assigned percentage values.

These percentage values are then converted to the corresponding dB values for the logarithmic amplitude scale of the spectrum analyzer using the following formula:

$$x[db] = 20 \cdot \log\left(\frac{x[\%]}{100}\right)$$

Formula 1: Converting percentage to dB

The calculated value shows the difference in dB to the 100 % value. Table 2 shows the most important percentage values in line with the ISO/IEC 14443 Type A envelope measurement at 106 kbit/s.

Percentage	Difference in dB at 100% dB value
110 %	+ 0.83
90 %	-0.91 dB
60 %	-4.43 dB
5 %	-26.02 dB

Table 2 Converting from percentage to dB

The required time parameters t1 to t4 can be determined by using markers placed at the corresponding dB values of the envelope. In the following four illustrations, the individual times for the modulation pause are measured at 100 % ASK in line with ISO/IEC 14443 Type A.

Measurements on RFID Components according to 14443

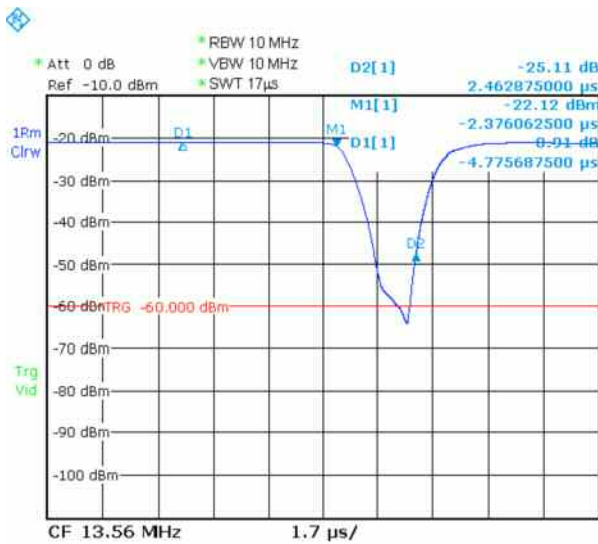

Fig. 8 Measuring t_1

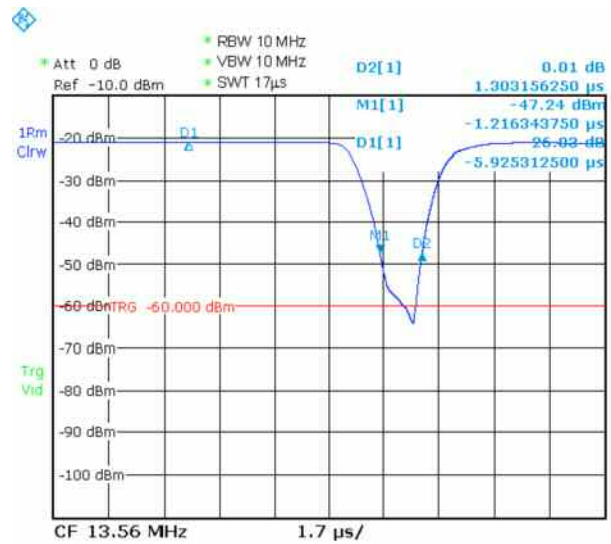

Fig. 9 Measuring t_2

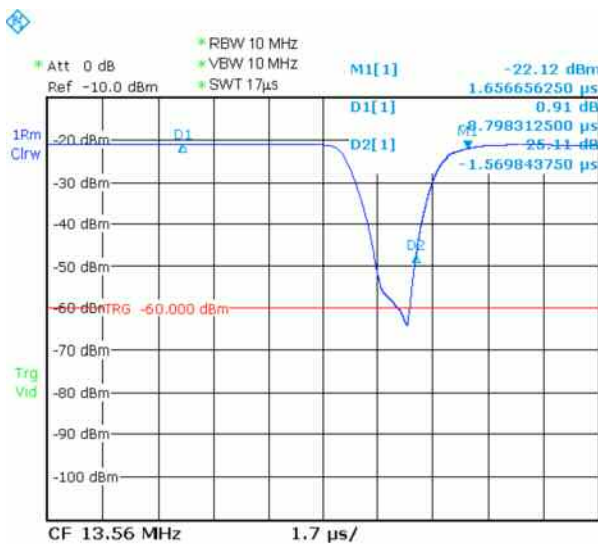

Fig. 10 Measuring t_3

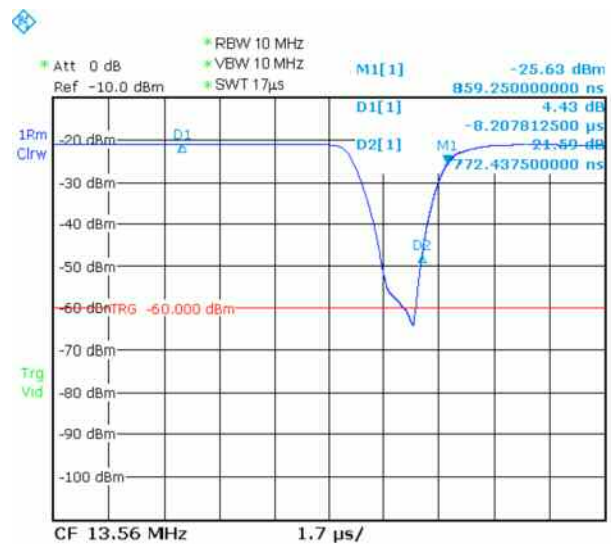

Fig. 11 Measuring t_4

The following settings must be made on the spectrum analyzer (e.g. the R&S®FSL) to perform a t_1 measurement of the modulation pause in the time domain.

PRESET

FREQ: 13,56 MHz

SPAN:*ZeroSpan*

BW:*10 MHz*

SWEEP:*SWEEP Points:32001*

MKR:*More:More:Marker Stepsize:Stepsize Sweep Points*

After the sweep time and trigger offset are set, a modulation pause as shown in Fig. 8 should be displayed on the analyzer.

Place markers D1, M1, and D2 to determine t_1 .

MKR:*Marker:Marker Delta*

- Position the D1 marker to H_{initial} (100 % amplitude value).

MKR:*Marker1*

- Position the M1 marker to 90 % amplitude value of the falling edge. This corresponds to the D1 value of 0.91 dB.

MKR:*Marker2:Marker Delta*

- Position the D2 marker to 5 % amplitude value of the rising edge. This corresponds to the D2 value of -25.11 dB.

The parameter t_1 can now be read as the value of D2.

The measurement of parameters t_2 , t_3 , t_4 is carried out in the same way.

For parameter t_2 , marker M1 is set to the 5 % amplitude value of the falling edge, which corresponds to a D1 value of 26.02 dB. Marker D2 now has a value of 0 dB. Parameter t_2 can now be read as the value of D2.

For parameter t_3 , marker M1 is set to the 90 % amplitude value of the rising edge, which corresponds to a D1 value of 0.91 dB. Marker D2 now has a value of -25.11 dB. Parameter t_3 can now be read as the value of D2.

For parameter t_4 , marker M1 is set to the 60 % amplitude value of the rising edge, which corresponds to a D1 value of 4.43 dB. Marker D2 now has a value of -21.59 dB. Parameter t_4 can now be read as the value of D2.

The spectrum analyzer shows the exact envelope of the PCD carrier signal without the RF curve that disrupts this measurement. In comparison to a digital scope, this considerably simplifies the positioning of the markers and thus the reading of the individual times.

6 Signal Analysis on Chipcards (PICCs)

Frame Delay Time

For Type A cards, the frame delay time defines the delay between two frames in different transmission directions, e.g. from the end of the PCD transmission to the start of the PICC transmission. A distinction must be made as to whether the final bit of the PCD transmission was a 1 or a 0, as shown in Fig. 12. The frame delay time is significant for the anticollision method used by Type A RFID systems. In order to detect the number and type of bit collisions and then to evaluate them based on the binary search tree anticollision algorithm, all RFID cards found in the operating field must respond to a transmitted REQA frame at a fixed, synchronized time.

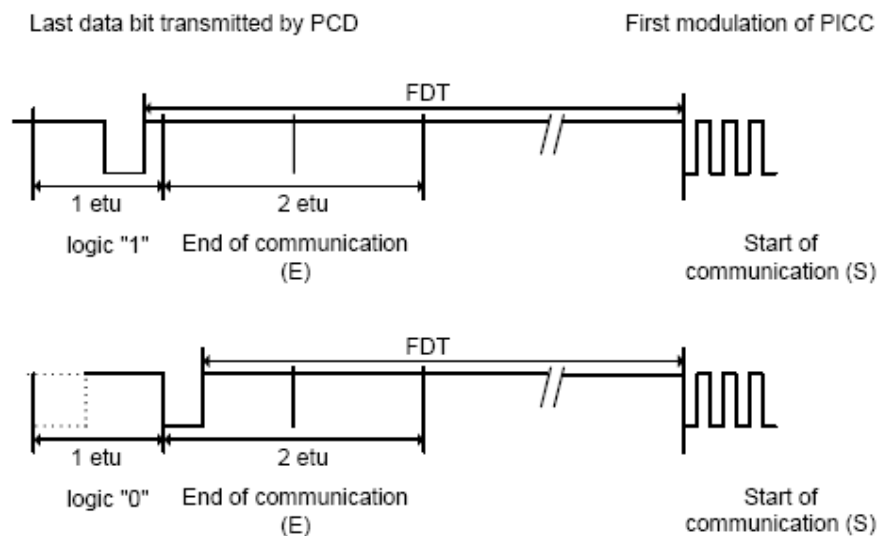

Fig. 12 Frame delay time PCD to PICC

Parameters	Values
FREQ	13.56 MHz
SPAN	Zero Span
SWT	~100µs
Trg Delay	~70µs
RBW	10 MHz

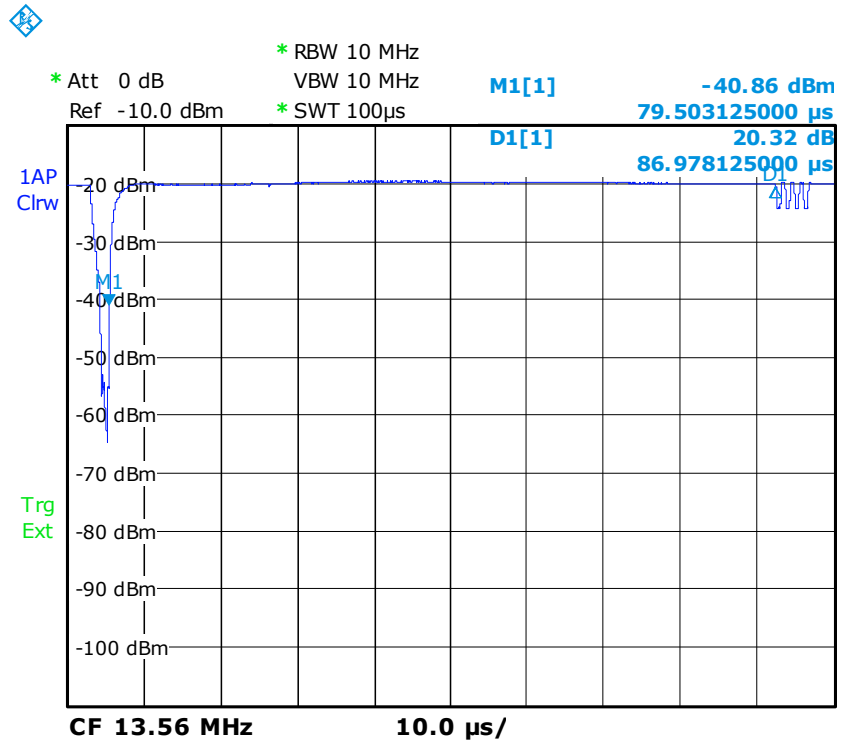

Fig. 13: Measuring the frame delay time
(ISO/IEC 14443 Type A 106 kbit/s)

The resolution bandwidth (RBW) of the spectrum analyzer should be selected to be as large as possible to prevent the time measurement from being influenced by the settling time. For this setting, the analyzer display should just show the final edge of the PCD signal and the start of the PICC response. The number of sweep points must be set to a high value (16001 or 32001), depending on the desired degree of accuracy. The configuration values mentioned above provide a sample resolution of about 3 ns per sample (at 32001 sweep points).

Setting the R&S®FSL for a frame delay time measurement with a REQA command:

PRESET

FREQ:13,56 MHz

SPAN:ZeroSpan

BW:10 MHz

Measurements on RFID Components according to 14443

SWEEP: *Sweep Points:32001*

After the appropriate sweep time and the optimum trigger offset are set, a signal trace as shown in Fig. 13 should be displayed on the analyzer.

Setting markers M1 and D1 for measuring the frame delay time

MKR: *More:More:Marker StepSize:StepSize SweepPoints*

MKR: *Marker1*

- Position marker M1 at the last rising edge of the PCD signal.

MKR: *Marker Delta*

- Position marker D1 at the first falling edge of the PICC response.

The frame delay time can now be read as the value of marker D1. Refer to Fig. 13.

Load Modulation

The amplitude measurement of the load modulation sideband is described in ISO/IEC 14443-2. According to the standard, the amplitude of a PICC load modulation must at least correspond to the value

$$\frac{22}{H^{0,5}} mV$$

where H is the rms value of the magnetic field strength in A/m . The PCD must be capable of receiving a load modulation of the amplitude

$$\frac{18}{H^{0,5}} mV$$

This results in the following curves:

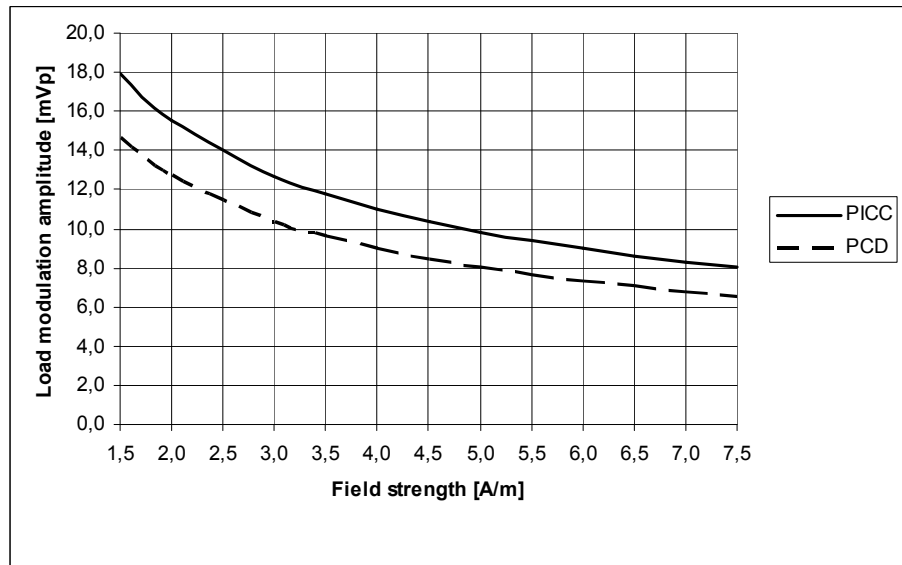

Fig. 14: Load modulation amplitude as a function of field strength

The measurement of the magnetic field strength H is carried out by measuring the voltage on a reference chipcard that emits a voltage corresponding to the magnetic field strength.

ISO/IEC 10373-6 "Identification Cards-Test Methods-Proximity Cards" describes the measurement of the load modulation with a digital scope. To do this, a precisely defined segment of the load modulation signal must be subjected to fast Fourier transform (FFT).

Measurements on RFID Components according to 14443

Measurements with a spectrum analyzer can be performed in two different ways, either in the time domain or in the frequency domain as a gated measurement. It is recommended to use the following selective time domain power measurement with a channel filter.

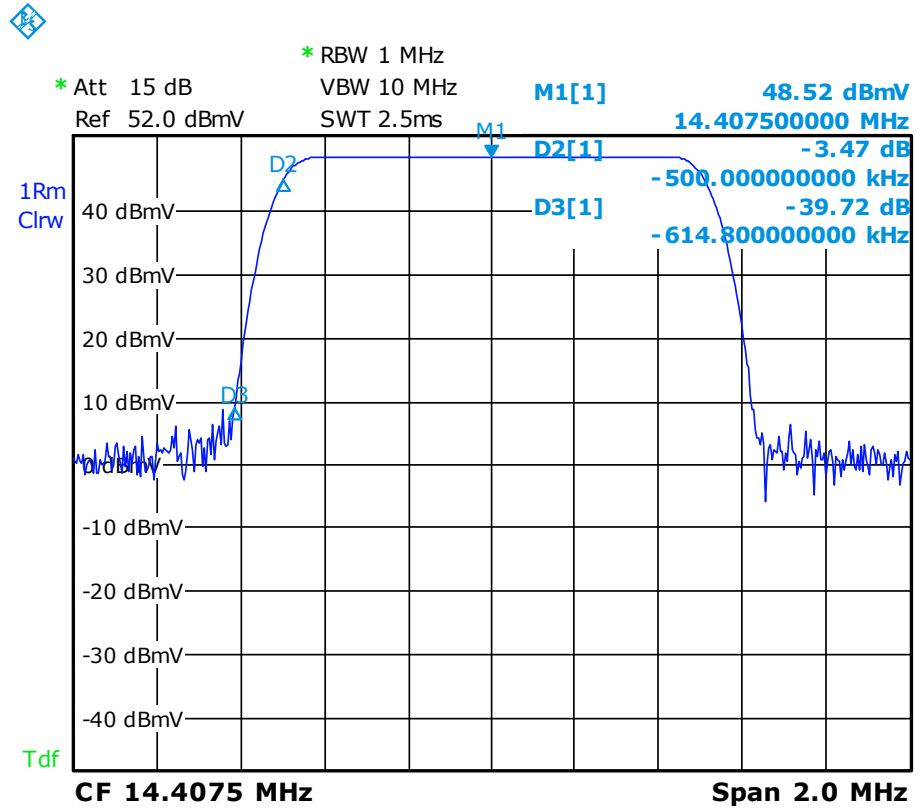

Fig. 15 Channel filter with 1 MHz bandwidth

The channel filter completely suppresses the carrier 13.56 MHz and, with the level amplitude response in a wide passband, ensures accurate measurement of the modulation spectrum, even at high bit rates.

Time Domain Power Measurement

To determine the load modulation amplitude in the time domain, the time domain power measurement of the spectrum analyzer is used. This measurement allows signal strength indicators that are limited in time to be detected in zero span mode. By selecting the center frequency as one of the two center frequencies of the modulation sidebands ($f_s = 12.712$ MHz and 14.4075 MHz), and by using a channel filter at a resolution bandwidth of 1 MHz, an adequate carrier suppression is ensured (Fig. 15).

For correct power rating in the time domain, an RMS detector must be selected. Sweep time and trigger delay must be set so that the complete response signal of the PICC is recorded. The start and end points of the measurement are defined with lines S1 and S2. The RMS value of the time domain power measurement can then be read.

Parameters	Values
FREQ	14.4075 MHz
SPAN	Zero Span
RBW	1 MHz
Filter Type	Channel
Detector	RMS
Unit	dBmV

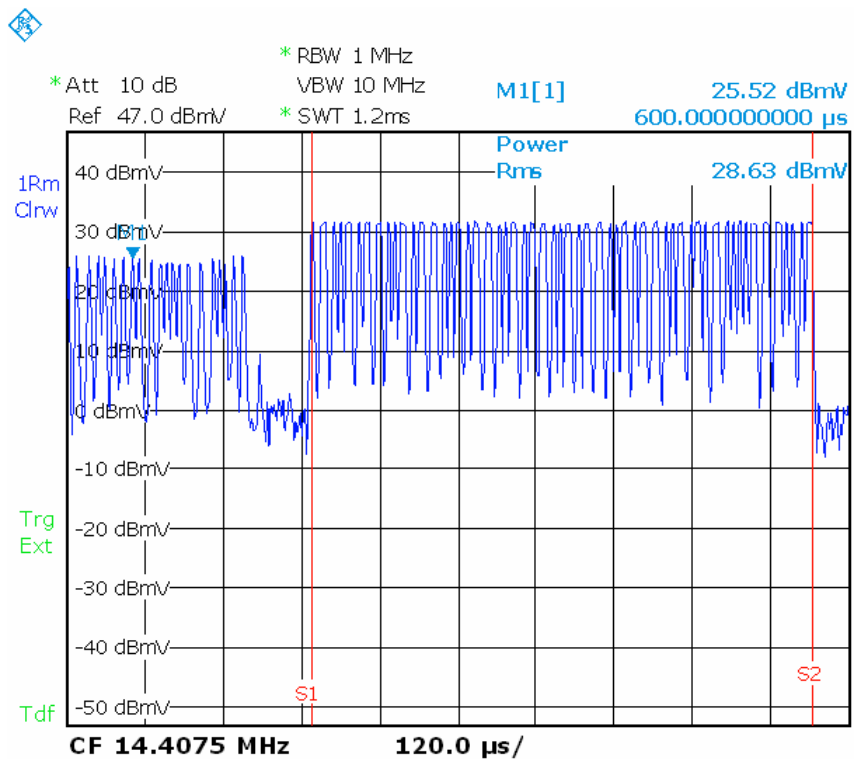

Fig. 16 Measurement - time domain power of load modulation (ISO/IEC 14443 Type A 106kbit/s)

Measurements on RFID Components according to 14443

The following settings must be made on a spectrum analyzer (e.g. the R&S®FSL) in order to measure the time domain power of the load modulation amplitude.

PRESET

FREQ:*14,4075 MHz / 12,712MHz*

SPAN:*ZeroSpan*

BW:*1 MHz*

AMPT:*Unit: dBmV*

BW:*FilterType Channel*

TRACE:*DetectorManualSelect: RMS*

MEAS:*TimeDomainPower: LeftLimit*

- Position limit line S1 to the start of the load modulation signal.

MEAS:*TimeDomainPower: RightLimit*

- Position limit line S2 to the end of the load modulation signal.

MEAS:*TimeDomainPower: PEAK*

The RMS and PEAK values of the load modulation can now be read.

Switching between the twomodulation sidebands can be done by using the center frequency stepsize option.

FREQ:*CF-Stepsize: Manual: 847.5 kHz*

Pressing the Arrow Up and Arrow Down key twice changes the frequency from the lower sideband to the uppersideband and the other way round.

Important

According to the ISO/IEC 10373-6 standard, measurement of the load modulation amplitude using FFT should result in the peak value of a sinewave modulation signal. A spectrum analyzer, on the other hand, is calibrated to the RMS value of a sinewave signal (for measurements with peak, RMS, or sampling detector).

In the case of a sinewave signal, it therefore displays 3 dB less. If Amplitude Shift Keying is used with an average duty cycle of 0.5 (OOK-Modulation for 14443 Type A chipcards and a bit rate of 106 kbit/s), the RMS detector of the analyzer will show half power, i.e. another 3 dB less.

Fig. 17 Measurement - time domain power of load modulation
(ISO/IEC 14443 Type B 106 kbit/s)

Electromagnetic Disturbance

The electromagnetic disturbance (EMD) value refers to the EMD parasitically generated by the PICC through the activities of the digital circuits. A too-high EMD level can disrupt the communication between the reader and the card because it can be incorrectly interpreted by the reader as a valid card signal. Therefore, the EMD emitted by the chipcards immediately before their response must not exceed a maximum value.

The EMD, just like load modulation, is determined with a time domain power measurement using the spectrum analyzer. In the example (Fig.18), the measured PICC emits increased EMD in the range between the two time markers S1 and S2. In the critical range (PICC silent time), about 120 μs before the PICC response in this example, the measured level is significantly lower.

Parameters	Values
FREQ	14.4075 MHz
SPAN	Zero Span
RBW	1 MHz
Filter Type	Channel
Detector	RMS
MEAS	TD Power
TraceMode	Average
Unit	dBmV

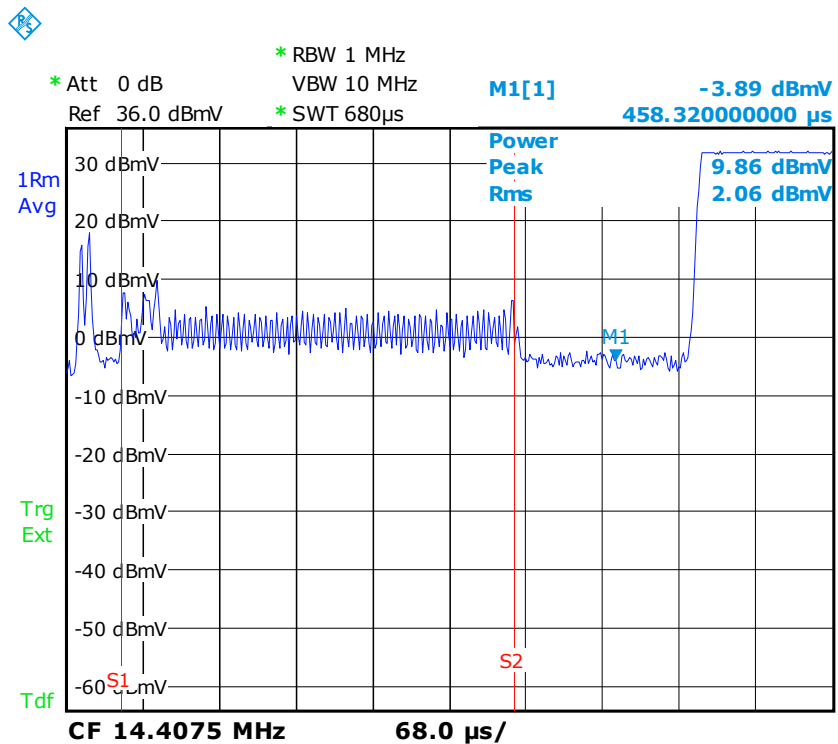

Fig.18 EMD measurement - time domain power
(ISO/IEC 14443 Type B 106 kbit/)

Measurements on RFID Components according to 14443

The following settings must be made on the spectrum analyzer (e.g. the R&S®FSL) in order to measure the time domain power of the EMD. Care must be taken that peak values of the PCD modulation are not incorrectly interpreted as EMDs and included in the measurement. It can be useful, at a frequency of 13.56 MHz, to set a marker at the final edge of the PCD signal before step 2. This allows a distinction to be made between the PCD and the EMD signal.

PRESET

FREQ:14.4075 MHz

SPAN:ZeroSpan

BW:1 MHz

AMPT:Unit:AMPT:dBmV

TRACE:TraceMode:Average

TRACE:DetectorManualSelect:RMS

BW:FilterType:Channel

After the appropriate trigger offset and sweep time are selected, the EMD should be displayed as shown in Fig.18.

MEAS:TimeDomainPower:LeftLimit

- Position limit line S1 to the start of the EMD signal.

MEAS:TimeDomainPower:RightLimit

- Position limit line S2 to the end of the EMD signal.

MEAS:TimeDomainPower:PEAK

The RMS and peak values of the EMD signal can now be read.

7 Abbreviations

Abbrev.	Meaning
AM	Amplitude modulation
ARB	Arbitrary
ASK	Amplitude shift keying
ATQA	Answer to request A
ATQB	Answer to request B
BPSK	Binary phase shift keying
CF	Carrier frequency
CRC	Cyclic redundancy check
CW	Continuous wave
DUT	Device under test
EMD	Electromagnetic disturbance
ETU	Elementary time unit
FDT	Frame delay time
FFT	Fast Fourier transform
FM	Frequency modulation
FSK	Frequency shift keying
FWT	Frame wait time
IEC	International Electrotechnical Commission
ISO	International Organization for Standardization
LSB	Least significant bit
MSB	Most significant bit
NRZ	Non return to zero
OOK	On-off keying
PCD	Proximity coupling device
PICC	Proximity integrated coupling circuit

Measurements on RFID Components according to 14443

RBW	Resolution bandwidth
REQA	Request command Type A
REQB	Request command Type B
RF	Radio frequency
RFID	Radio frequency identification
RMS	Root mean square
SWT	Sweep time
WUPA	Wake up command A
WUPB	Wake up command B

8 References

- [1] ISO/IEC 10373-6 Identification cards - Test methods Part 6: Proximity cards
- [2] ISO/IEC 14443-1 Identification cards – Contactless integrated circuit(s) cards – Proximity cards – *Part 1: Physical characteristics*
- [3] ISO/IEC 14443-2 Identification cards – Contactless integrated circuit(s) cards – Proximity cards – *Part 2: Radio frequency power and signal interface*
- [4] ISO/IEC 14443-3 Identification cards – Contactless integrated circuit(s) cards – Proximity cards – *Part 3: Initialization and anti-collision*
- [5] ISO/IEC 14443-4 Identification cards – Contactless integrated circuit(s) cards – Proximity cards – *Part 4: Transmission protocol*
- [6] R&S®FSL Signal Analyzer – Operating Manual
- [7] R&S®FSP Signal Analyzer – Operating Manual
- [8] R&S®FSQ Signal Analyzer – Operating Manual
- [9] R&S®ZVL Vector Network Analyzer – Operating Manual
- [10] R&S®SMU200A Vector Signal Generator – Operating Manual
- [11] R&S®SMJ100A Vector Signal Generator – Operating Manual
- [12] R&S®AMU200A Baseband Signal Generator – Operating Manual
- [13] R&S® xxx-K6 Pulse Sequencer Software Manual 1171.5202.42-01

9 Additional Information

This Application Note is being continuously updated. Please visit the [1MA113](#) website in order to download new versions. Please send any comments or suggestions about this Application Note to TM-Applications@rsd.rohde-schwarz.com.

10 Appendix

Generating ISO/IEC 14443 Type A Signals

To generate ISO/IEC 14443 Type A frames using the R&S@xxx-K6 pulse sequencer software, the external modulation plugin "ISO/IEC14443-2, TypeA" must be selected (ASK with modified Miller coding, the plugin comes along with this application note). It offers several modulation parameter settings (see Fig. 20). For further information how to deal with plugins and create signals with the R&S@xxx-K6 pulse sequencer software please refer to the R&S@xxx-K6 pulse sequencer software manual.

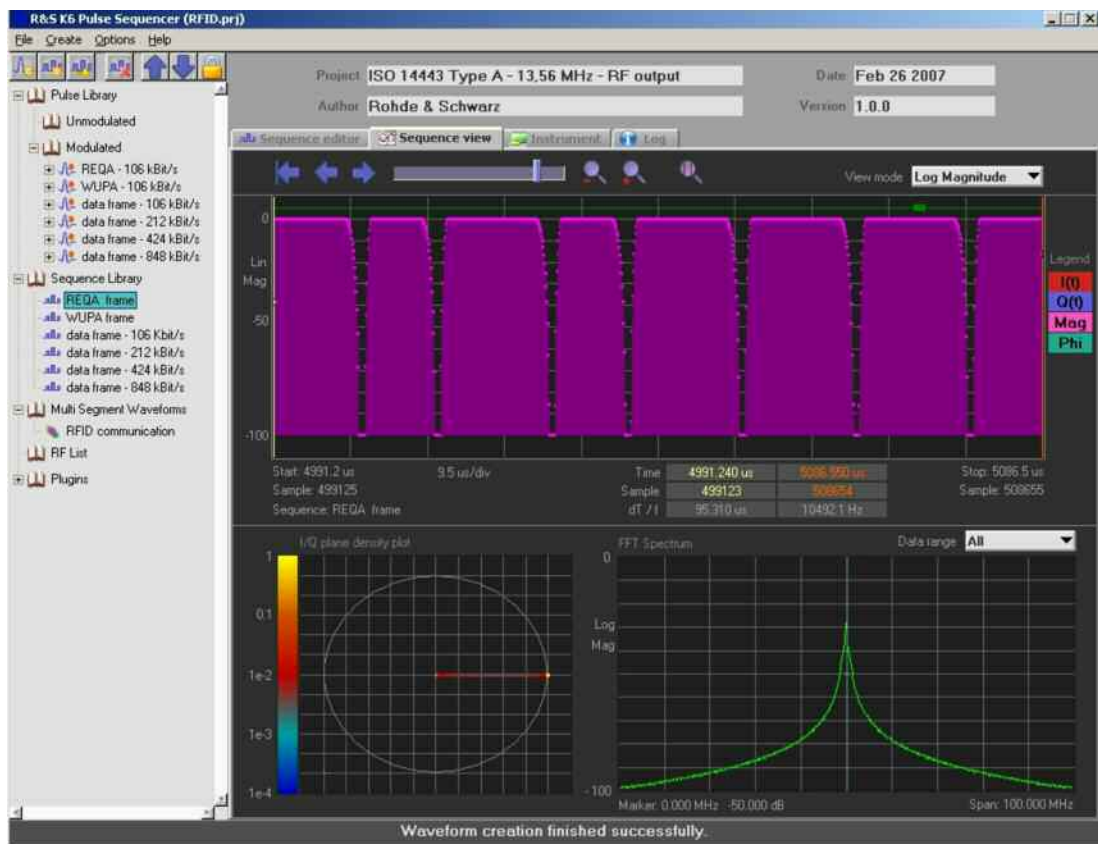

Fig. 19 R&S@xxx-K6 pulse sequencer - sequence view

Measurements on RFID Components according to 14443

- T_{fall}: Represents the duration of the falling edge.
- T_{low}: Represents the duration of the "low level".
- T_{rise}: Represents the duration of the rising edge.
- Rate: Sets the kbit/s rate for the RFID frame.
- Mod Index: Represents the modulation index of the amplitude modulation.

The bit sequence data to be generated is entered in the "User bit pattern" screen.

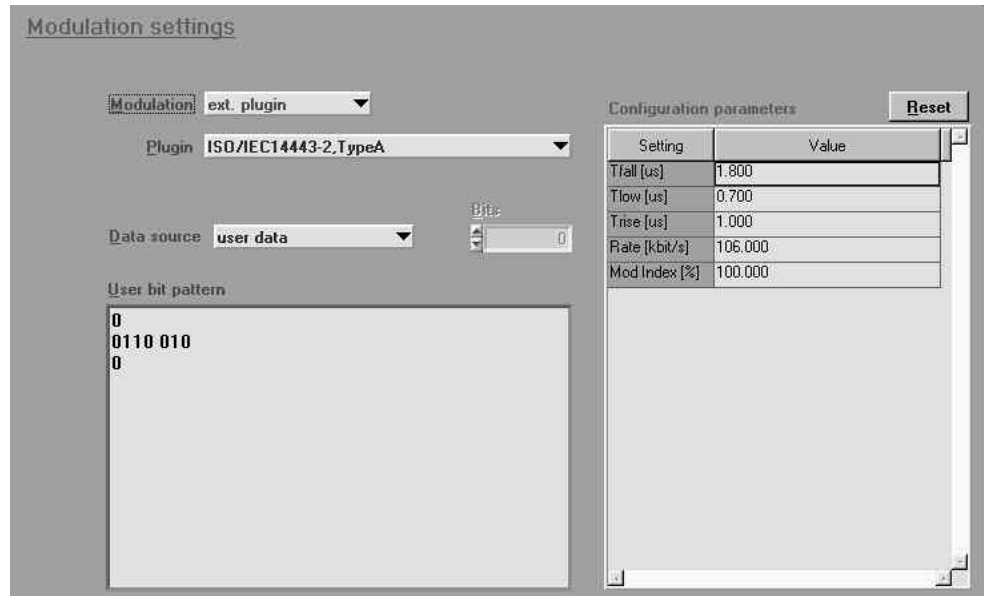

Fig. 20 Modulation settings of the ISO/IEC 14443 Type A plugin

As an example of signal generation, the creation of an REQA frame in the baseband is explained below. By means of generation in the IF, an I/Q signal can be created. After starting the R&S@xxx-K6 pulse sequencer, the following steps should be completed:

1. Set a new pulse using the menu option: Create_New Pulse
2. Configure the pulse parameters:
 - Timing: on time: 84.91 μ s

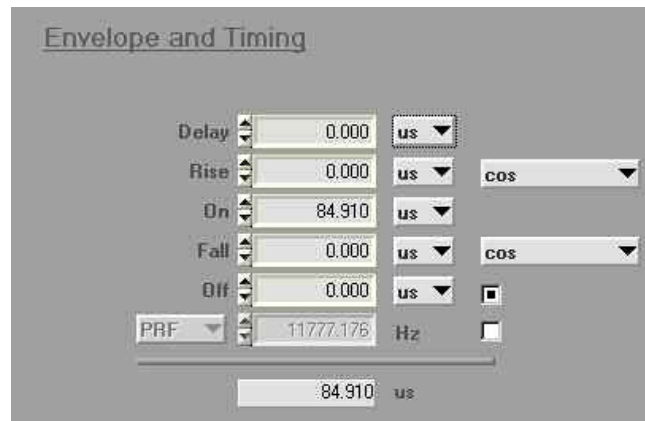

Fig. 21 timing settings

- Level: level att(on): 0.00 dB
Level att(off): 100.00 dB
Continue phase: active
Frequency offset: 13.56 MHz

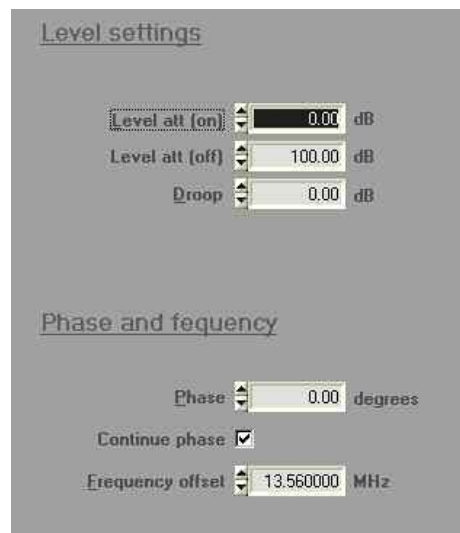

Fig. 22 level settings

Measurements on RFID Components according to 14443

- Jitter: no jitter
- Modulation: external plugin – plugin: ISO/IEC 14443-2 Type A
Data source: user data
Use bit pattern: 0 0110010 0

Modulation settings

Modulation: ext. plugin

Plugin: ISO/IEC14443-2,TypeA

Data source: user data

Bits: 0

User bit pattern

```
0
0110 010
0
```

Fig. 23 modulation settings

- Marker: marker 1: restart

Marker settings

	Marker 1	Marker 2	Marker 3	Marker 4
Delay	<input type="checkbox"/>	<input type="checkbox"/>	<input type="checkbox"/>	<input type="checkbox"/>
Rise	<input type="checkbox"/>	<input type="checkbox"/>	<input type="checkbox"/>	<input type="checkbox"/>
On	<input type="checkbox"/>	<input type="checkbox"/>	<input type="checkbox"/>	<input type="checkbox"/>
Fall	<input type="checkbox"/>	<input type="checkbox"/>	<input type="checkbox"/>	<input type="checkbox"/>
Off	<input type="checkbox"/>	<input type="checkbox"/>	<input type="checkbox"/>	<input type="checkbox"/>
Restart	<input checked="" type="checkbox"/>	<input type="checkbox"/>	<input type="checkbox"/>	<input type="checkbox"/>

(active for first 10% of PRI)

Fig. 24 marker settings

Measurements on RFID Components according to 14443

3. Generate a continuous wave signal in the baseband. Create a new pulse using the menu option: Create_New Pulse
4. Configure the pulse parameters:
 - Timing: on time: 1ms
 - Level: level att(on): 0.00 dB
Level att(off): 100.00 dB
Continue phase: active
Frequency offset: 13.56 MHz
 - Jitter: no jitter
 - Modulation: none
 - Marker: no marker
5. Generate a new pulse sequence using the menu option: Create_New Sequence
6. Configure the sequence in the Sequence Editor:

Item	Mode	Tstart [us]	Tstop [us]	Samples	Pulse Object	Rep.	Jitter 1	Jitter 2	Jitter 3	M 1	M 2	M 3	M 4
1	---	0.00	5000.00	500000	ZF - CW	5	off	off	off	OFF	OFF	OFF	OFF
2	---	5000.00	5084.91	8491	ZF - REQA - 106 kBit/s	1	off	off	off	1ST	OFF	OFF	OFF
3	---	5084.91	6084.91	100000	ZF - CW	1	off	off	off	OFF	OFF	OFF	OFF
4	---	6084.91	7000.00	91509	T -> (blank filler)	0	---	---	---	OFF	OFF	OFF	OFF

Fig. 25 REQA Frame in the Sequence Editor

- Add a new pulse to the sequence:
 - Click the button: Create New Sequence Entry
 - Pulse Object: Select the generated 1 ms continuous wave signal.
 - Rep.: 5

5ms continuous wave signal for power supply to the card.

- Add a new pulse to the sequence:
 - Click the button: Create New Sequence Entry
 - Pulse Object: Select the generated REQA pulse.

Measurements on RFID Components according to 14443

- Add a new pulse to the sequence:
 - Click the button: Create New Sequence Entry
 - Pulse Object: Select the generated 1 ms continuous wave signal.
 - Rep.: 1

- Add a new pulse to the sequence:
 - Click the button: Create New Sequence Entry
 - Pulse Object: T →| (blank filler)
 - Tstop[us]:7000[us] or any other duration.

7. Generate the waveform:

- Click the Create Waveform button.

The generated waveform can now be viewed in the Sequence View.

8. Transmit to a signal generator:

- Select the signal generator in the submenu: Instrument
- Set the signal frequency and power for the corresponding generator path from this menu.
- Transmit the waveform by clicking the Start Transfer button.

The generator being used must be equipped with the R&S@xxx-K6 pulse sequencer software option in order to process the waveform files created with the pulse sequencer.

Measurements on RFID Components according to 14443

To generate separate RFID signals, the on time of the pulse must be calculated. This differs based on the length and bit rate of the RFID frame. The time unit of a bit is specified by the etu (elementary time unit) and shown in the following table.

Bit rate	Bit duration (etu)
$fc/128$ (~106 kbit/s)	$128/fc$ (~9.4 μ s)
$fc/64$ (~212 kbit/s)	$128/(2fc)$ (~4.7 μ s)
$fc/32$ (~424 kbit/s)	$128/(4fc)$ (~2.4 μ s)
$fc/16$ (~847 kbit/s)	$128/(8fc)$ (~1.2 μ s)

Table 3 Bit rates and corresponding bit duration

The duration of an RFID frame is based on the number of bits to be transmitted. In the case of a short frame, as for the REQA command, 9 bits are transmitted. This includes two bits for the start and end of the communication (each a logical "0"), plus 7 bits of data. The least significant bit (LSB) is transmitted first. Short frames are used at the start of the communication and have a data rate of 106 kbit/s, making the duration of a REQA command $9 \times 9.4 \mu\text{s} = 84.91 \mu\text{s}$.

In the case of standard frames with higher bit rates, the on time for the pulse is calculated based on the number of data bits being sent, the start- and end-of-frame bits, appended parity and CRC bits, and the bit duration.

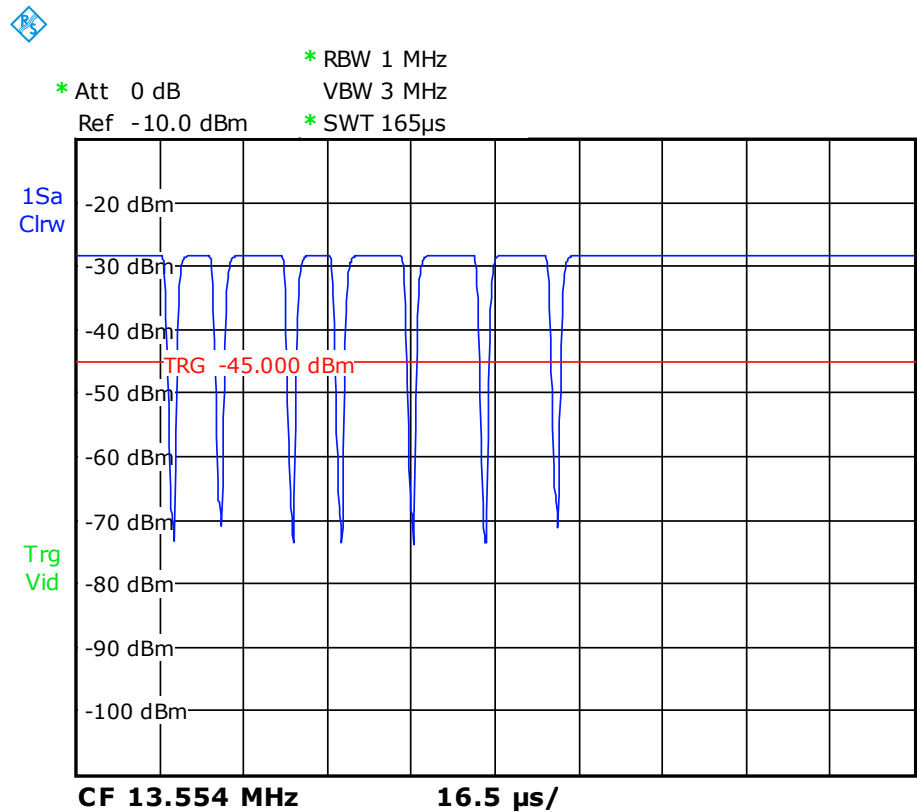

Fig. 26 Generated REQA frame measured with the R&S®FSL

Generating ISO/IEC 14443 Type B Signals

Signal structure

Signals of the Type B interface are generated with an amplitude modulation with a modulation index of 10 %. NRZ coding is used for a Type B-compliant signal. This section describes the complete setup of a Type B signal. An signal generation example is described using an REQB frame.

Character format

Bytes are transmitted as characters in the following format during the anticollision routine between the PCD and PICC.

- One start bit containing logical "0"
- 8 data bits; the LSB is transmitted first
- One stop bit with logical "1"

The duration of a character is thus 10 etu.

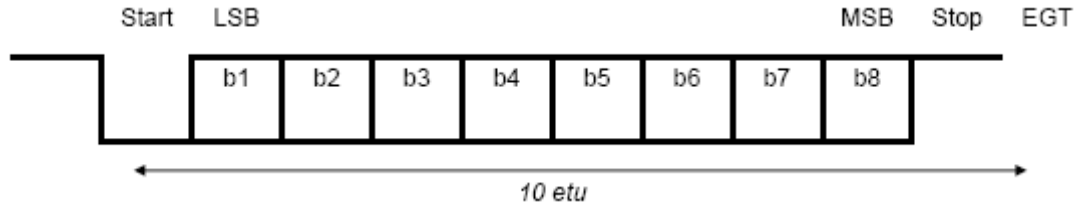

The separation between two character blocks is ensured by means of an extra guard time (EGT). It lies between 0 etu and 2 etu for the PICC-to-PCD transmission and between 0 etu and 6 etu for the PCD-to-PICC transmission.

Frame Format

The PCD and PICC send any number of characters as a frame.

A frame begins with a start of frame (SOF) and ends with an end of frame (EOF).

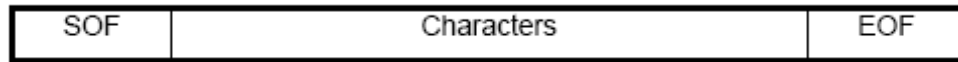

The start of frame includes the following:

- Start of a falling edge
- Followed by a logical "0" level; duration: >10 etu and <11 etu
- Followed by a logical "1" level; duration: >2 etu and <3 etu

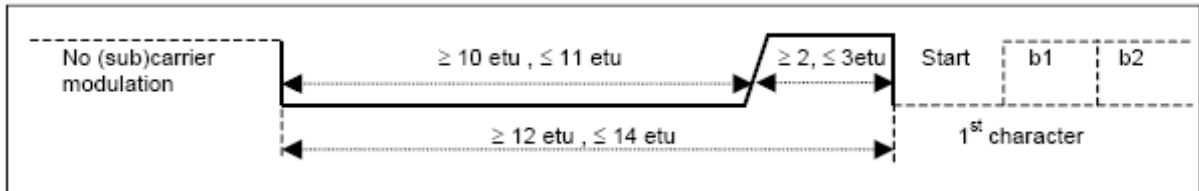

Fig. 27 Type B - start of frame

The end of frame includes the following:

- Start of a falling edge
- Followed by a logical "0" level of >10 etu and <11 etu
- Followed by a rising edge

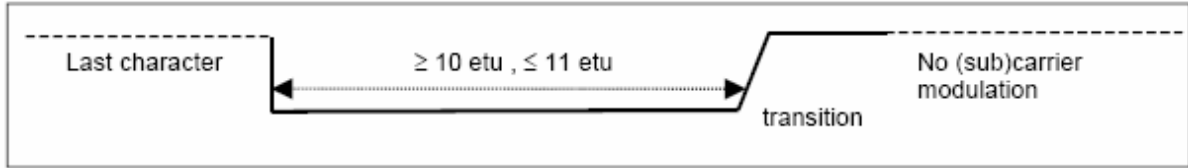

Fig. 28 Type B - end of frame

REQB and WUPB command

The REQB and WUPB frames have the following format.

1 st byte	2 nd byte	3 rd byte	4 th , 5 th bytes
APf (1 byte)	AFI (1 byte)	PARAM (1 byte)	CRC_B (2 bytes)
MSB	LSB MSB	LSB MSB	LSB MSB

APf (anticollision prefix) = `05` = (0000 0101)b

AFI (application family identifier) = for the response of all PICCs to an REQB or WUPB, AFI = `00` must be selected = (0000 0000)b

PARAM:

The following illustration shows the structure of the PARAM byte:

b8	b7	b6	b5	b4	b3	b2	b1
RFU			Extended ATQB supported	REQB / WUPB	N (Number of slots)		

All RFU bits (b6 – b8) must be set to 0.

Bit 5 shows whether the PCD supports an extended ATQB.

Bit 4 defines an REQB (b4=0) or WUPB frame (b4=1).

Bit 1 to bit 3 code the number of slots used.

b3	b2	b1	N
0	0	0	1 = 2 ⁰
0	0	1	2 = 2 ¹
0	1	0	4 = 2 ²
0	1	1	8 = 2 ³
1	0	0	16 = 2 ⁴
1	0	1	RFU
1	1	x	RFU

Signal Generation

Using the R&S@xxx-K6 pulse sequencer, a Type B signal can be generated in a manner similar to the Type A description above using the ISO/IEC 14443-2 Type B modulation plugin delivered with this application note.

As an example of signal generation, the creation of an REQB frame in the baseband is described here. By means of generation in the IF, an I/Q signal can be created. After starting the R&S@xxx-K6 pulse sequencer, the following steps must be carried out:

1. Create a new pulse using menu option: Create_New Pulse
2. Configure the pulse parameters for the *start of frame* (SOF):
 - Timing: on time: 112.8 μ s
 - Level: level att(on): 0.00 dB
level att(off): 100.00 dB
continue phase: active
frequency offset: 13.56 MHz
 - Jitter: no jitter
 - Modulation: external plugin: ISO/IEC 14443-2 Type B
Data source: user data
use bit pattern: 000000000011
configuration parameters:
rate: 106 kbit/s
mod index: 10%
 - Marker: marker 1: restart
3. Create a new pulse using the menu option: Create_New Pulse

4. Configure the pulse parameters for the *end of frame* (EOF):
 - Timing: on time: 94 μ s
 - Level: level att(on): 0.00 dB
level att(off): 100.00 dB
continue phase: active
frequency offset: 13.56 MHz
 - Jitter: no jitter
 - Modulation: external plugin: ISO/IEC 14443-2 Type B
Data source: user data
use bit pattern: 0000000000
configuration parameters:
rate: 106 kbit/s
mod index: 10%
 - Marker: no marker

5. Create a continuous wave signal in the baseband. Create a new pulse using the menu option: Create_New Pulse

6. Configure the pulse parameters for the IF CW pulse:
 - Timing: on time: 1ms
 - Level: level att(on): 0.00 dB
level att(off): 100.00 dB
continue phase: active
frequency offset: 13.56 MHz
 - Jitter: no jitter
 - Modulation: none
 - Marker: no marker

7. Create a new pulse using the menu option: Create_New Pulse

8. Configure the pulse parameters for the *Request B Frames* (REQB):

- Timing: on time: 470 μ s
- Level: level att(on): 0.00 dB
level att(off): 100.00 dB
continue phase: active
frequency offset: 13.56 MHz
- Jitter: no jitter
- Modulation: external plugin: ISO/IEC 14443-2 Type B
Data source: user data
use bit pattern:
0
10100000
1
0
00000000
1
0
00000000
1
0
10001110
1
0
11111111
1
configuration parameters:
rate: 106 kbit/s
mod index: 10%

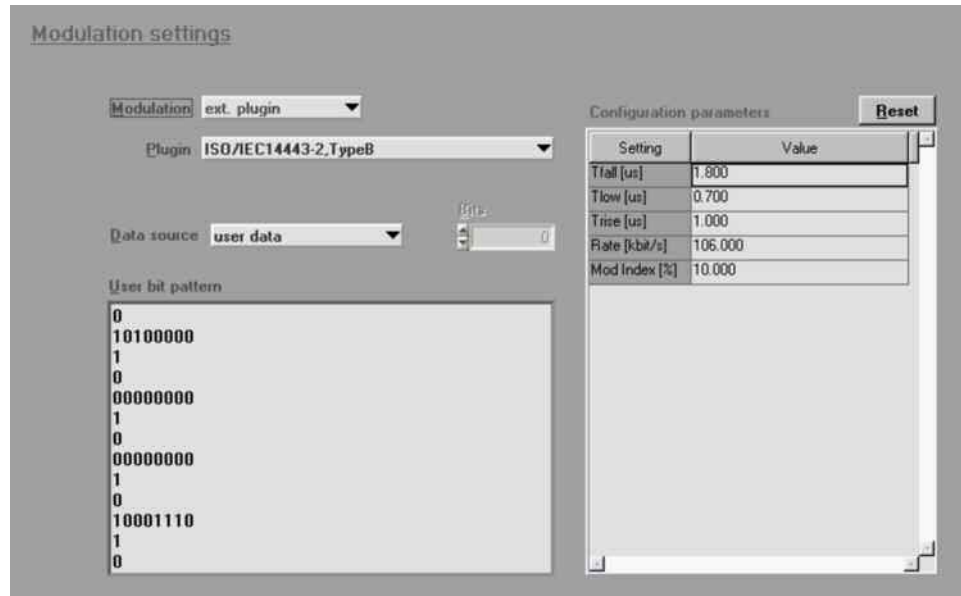

Fig. 29 modulation settings

- Marker: no marker
9. Create a new pulse sequence using the menu option: Create_New Sequence
 10. Configure the sequence in the Sequence Editor (see Fig. 30):
 - Add a new pulse to the sequence:
Click the button: Create New Sequence Entry
 - Pulse Object: Select the generated 1ms continuous wave signal
 - Rep.: 5

5 ms continuous wave signal for power supply to the card
 - Add a new pulse to the sequence:
Click the button: Create New Sequence Entry
 - Pulse Object: Select the generated SOF pulse
 - Rep.: 1
 - Add a new pulse to the sequence:
Click the button: Create New Sequence Entry
 - Pulse Object: Select the generated REQB pulse
 - Rep.: 1

Measurements on RFID Components according to 14443

- Add a new pulse to the sequence:

Click the button: Create New Sequence Entry

- Pulse Object: Select the generated EOF pulse
- Rep.: 1

- Add a new pulse to the sequence:

Click the button: Create New Sequence Entry

- Pulse Object: Select the generated 1ms continuous wave signal
- Rep.: 5

- Add a new pulse to the sequence:

Click the button: Create New Sequence Entry

- Pulse Object: T →| (blank filler)
- Tstop[us]: 11000[us] or any other duration

11. Generate the waveform:

- Click the Create Waveform button

The generated waveform can now be viewed in the Sequence View.

Item	Mode	Tstart [us]	Tstop [us]	Samples	Pulse Object	Rep.	Jitter 1	Jitter 2	Jitter 3	M1	M2	M3	M4
1	---	0.00	5000.00	500000	ZF-CW	5	off	off	off	OFF	OFF	OFF	OFF
2	---	5000.00	5112.80	11280	SOF	1	off	off	off	1ST	OFF	OFF	OFF
3	---	5112.80	5582.80	47000	REQB	1	off	off	off	OFF	OFF	OFF	OFF
4	---	5582.80	5676.80	9400	EOF	1	off	off	off	OFF	OFF	OFF	OFF
5	---	5676.80	10676.80	500000	ZF-CW	5	off	off	off	OFF	OFF	OFF	OFF
6	---	10676.80	11000.00	32319	T -> (blank filler)	0	---	---	---	OFF	OFF	OFF	OFF

Fig. 30 REQB frame in sequence view

12. Transmit to a signal generator:

- Select the signal generator in the submenu: Instrument
- Set the signal frequency and power for the corresponding generator path in this menu.
- Transmit the waveform by clicking the Start Transfer button

IMPORTANT !

The generator that is used must be equipped with the R&S®xxx-K6 pulse sequencer software option in order to process the waveform files generated with the pulse sequencer.

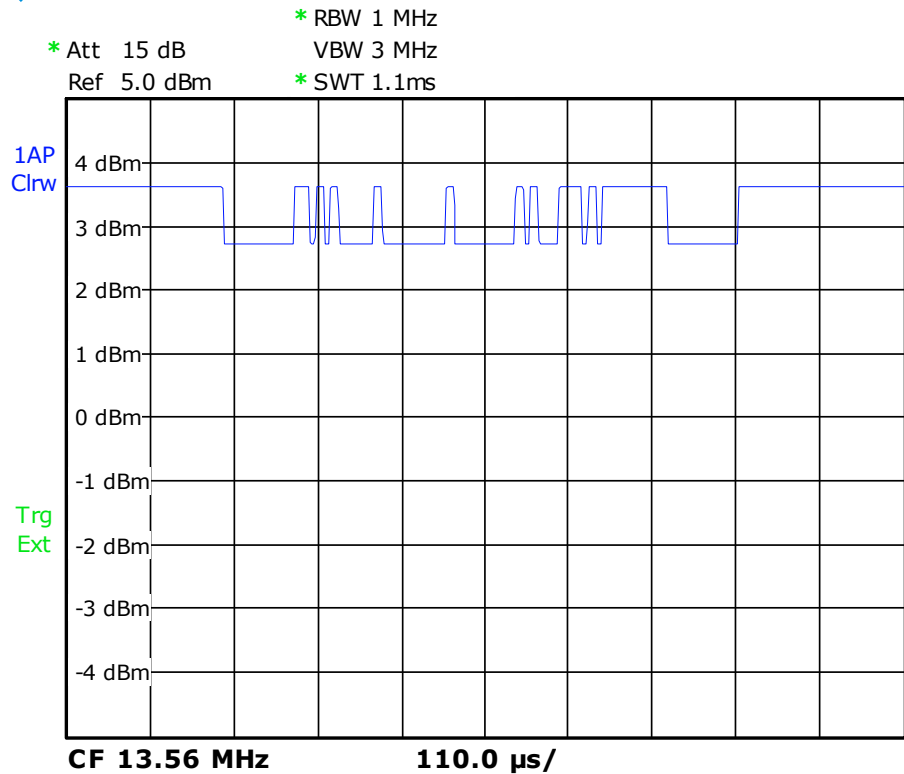

Fig. 31 Generated REQB frame measured using the R&S®FSL

11 Ordering Information

Spectrum analyzer

Designation	Frequency range	Order No.
R&S®FSL3	9 kHz to 3 GHz	1300.2502.03
R&S®FSL6	9 kHz to 6 GHz	1300.2502.06
R&S®FSP3	9 kHz to 3 GHz	1093.4495.03
R&S®FSP7	9 kHz to 7 GHz	1093.4495.07
R&S®FSP13	9 kHz to 13 GHz	1093.4495.13
R&S®FSP30	9 kHz to 30 GHz	1093.4495.30
R&S®FSP40	9 kHz to 40 GHz	1093.4495.40
R&S®FSQ3	20 Hz to 3.6 GHz	1155.5001.03
R&S®FSQ8	20 Hz to 8 GHz	1155.5001.08
R&S®FSQ26	20 Hz to 26.5 GHz	1155.5001.26
R&S®FSU3	20 Hz to 3.6 GHz	1166.1660.03
R&S®FSU8	20 Hz to 8 GHz	1166.1660.08
R&S®FSU26	20 Hz to 26.5 GHz	1166.1660.26
R&S®FSU46	20 Hz to 46 GHz	1166.1660.46

Vector Network Analyzer

R&S®ZVL3	9 kHz to 3 GHz	1303.6509.03
R&S®ZVL6	9 kHz to 6 GHz	1303.6509.06
R&S®ZVL-K1	Spectrum Analysis to R&S®ZVL	1306.0301.01

Signal Generator

R&S®SMJ100A	Vector Signal Generator	1403.4507.02
R&S®SMJ-B103	100 kHz to 3 GHz	1403.8502.02
R&S®SMJ-B106	100 kHz to 6 GHz	1403.8702.02
R&S®SMJ-B9	Baseband Generator with ARB (128 Msamples) and Digital Modulation	1404.1501.02
R&S®SMJ-B10	Baseband Generator with ARB (64 Msamples) and Digital Modulation	1403.8902.02
R&S®SMJ-B11	Baseband Generator with ARB (16 Msamples) and Digital Modulation	1403.9009.02
R&S®SMJ-B13	Baseband Main Module	1403.9109.02
R&S®SMJ-B50	Baseband Generator with ARB (64 Msamples)	1410.5505.02
R&S®SMJ-B51	Baseband Generator with ARB (16 Msamples)	1410.5605.02
R&S®SMJ-K6	Pulse Sequencer	1409.2558.02

Measurements on RFID Components according to 14443

R&S@SMU200A	Vector Signal Generator	1141.2005.02
R&S@SMU-B102	RF Path A: 100 kHz to 2.2 GHz	1141.8503.02
R&S@SMU-B103	RF Path A: 100 kHz to 3 GHz	1141.8603.02
R&S@SMU-B104	RF Path A: 100 kHz to 4 GHz	1141.8703.02
R&S@SMU-B106	RF Path A: 100 kHz to 6 GHz	1141.8803.02
R&S@SMU-B203	Baseband Generator with ARB (64 Msamples)	1141.9500.02
R&S@SMU-B9	Baseband Generator with ARB (128 Msamples) and Digital Modulation	1161.0766.02
R&S@SMU-B10	Baseband Generator with ARB (64 Msamples) and Digital Modulation	1141.7007.02
R&S@SMU-B11	Baseband Generator with ARB (16 Msamples) and Digital Modulation	1159.8411.02
R&S@SMU-B13	Baseband Main Module	1141.8003.02
R&S@SMU-K6	Pulse Sequencer	1408.7662.02
R&S@AMU200A	Baseband Signal Generator	1402.4090.02
R&S@AMU-B9	Baseband Generator (128 Msamples)	1402.8809.02
R&S@AMU-B10	Baseband Generator (64 Msamples)	1402.5300.02
R&S@AMU-B11	Baseband Generator (16 Msamples)	1402.5400.02
R&S@AMU-B13	Baseband Main Module	1402.5500.02
R&S@AMU-K6	Pulse Sequencer	1402.9805.02
R&S@AFQ100A	I/Q Modulation Generator	1401.3003.02
R&S@ AFQ-B10	Waveform Memory 256 Msample	1401.5106.02
R&S@ AFQ-B11	Waveform Memory 1 Gsample	1401.5206.02
R&S@ AFQ-K6	Pulse Sequencer	1401.5606.02



ROHDE & SCHWARZ GmbH & Co. KG · Mühldorfstraße 15 · D-81671 Munich · Postfach 80 14 69 · D-81614 München · Tel

(089) 4129 -0 · Fax (089) 4129 - 13777 · Internet: <http://www.rohde-schwarz.com>

This application note and the supplied programs may only be used subject to the conditions of use set forth in the download area of the Rohde & Schwarz website.